



Germicidal Lamps
MPUV Lamps
HP Lamps



**World Wide Suppliers
of Quality UVC Lamps**

Creating True Value and True Partnership



Company Profile:

Founded in 1983, LightSources Inc. has been offering superior products and processes for over 25 years to our OEM customers and is the leading manufacturer of quartz germicidal lamps in the world. In 1993, LightTech Lamp Technology Ltd. was started in Hungary in order to serve the growing demand for germicidal lamps and sleeves for both the European and Asian markets. The combination of our state of the art manufacturing facilities, technology and capability allow us to bring quality products to the market with reduced lead times and high performance. Both companies design and lamp manufacture for a wide variety of special lighting applications spanning multiple market segments within many industries and applications. While both companies core focus remains on germicidal, photochemical and skin tanning applications, we also manufacture specialty lamps for LCD backlighting and compact fluorescent applications. Both companies are recognized within their respective markets for excellence in product design and manufacture. We strive to meet our customers' unique requirements for performance, quality and reliability.



UV-Action:

- LightSources & LightTech low-pressure, mercury-arc germicidal lamps are specially designed to produce the highest amounts of uv radiation - where 90% of energy is typically generated at 254nm. This radiation is very close to the peak of the germicidal effectiveness curve of 265nm, the most lethal wavelength to microorganisms. (see graph).

Lamp Output vs. Effectiveness

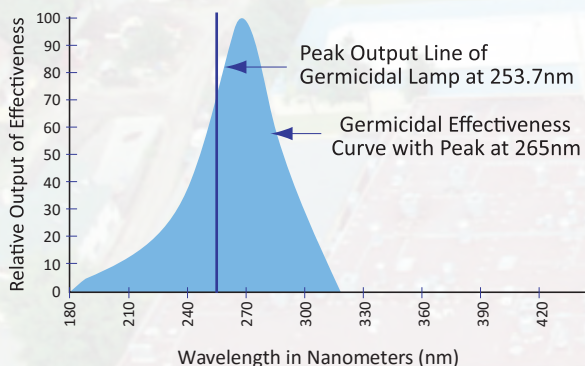

- Our germicidal lamps are used extensively in the air purification markets and have been utilized in applications such as food and beverage, medical, HVAC (Heating, Ventilation and Air Conditioning), pharmaceutical and the semiconductor sterilization industries.
- Our germicidal lamps are essential components in the drinking water, wastewater and ground water remediation industries as well.

Ozone-Action:

- "VH" (or Very High ozone producing lamps) generate energy at 185nm in addition to the 254nm wavelength.
- The UV emission at 185nm produces abundant amounts of ozone in air. Ozone is an extremely effective oxidizer, destroying microorganisms as well as reducing Total Organic Compounds (TOC).
- A primary advantage of the ozone generated by our UV germicidal lamps is that it can be carried through the air into places not easily reachable by direct UV exposure.

Advantages of UV Radiation:

- Environmentally friendly, no dangerous or toxic chemicals that require specialized storage and/or handling and there are no concerns of overdosing. Since no chemicals are added to the air/water there are no process by-products to be concerned with.
- Cost effective - low initial capital cost and reduced operating costs.
- Effective - UV radiation offers immediate treatment process with no requirements for holding tanks or long retention/exposure times.
- Compatibility - UV radiation is highly compatible with other water and air treatment processes while introducing no changes in taste, odor, pH, conductivity or chemical properties of the air/water in which it is used.

Index:

Amalgam Lamps:	1
Quartz Germicidal Lamps:	
High Output Lamps.....	5
Standard Output Lamps.....	3
Germipak UV Cell Lamps.....	6
U-Lamps.....	7
Subminiature UVC Lamps.....	10
R.P.T. UVC Lamps.....	13
All-in-One Submersible UVC Lamps..	14
Soft Glass Germicidal Lamps:	
Standard and HO Lamps.....	8
Compact Lamps.....	9
Medium Pressure UV Lamps:	
Custom Lamps.....	15
High Pressure UV Lamps:	
Custom Lamps.....	19
Quartz Sleeves:.....	11
Shatter ⁺ Technology:.....	11
Proprietary Bases & Sockets:	12



*Where Partnerships
are Valued*





Low Pressure Amalgam Germicidal Lamps

Our companies provide the widest range of high-quality spot and pellet amalgam lamps in the industry today; both standard and custom designs. Our low pressure amalgam lamps function with equal efficiency in both horizontal and vertical operation. Amalgam lamps yield up to three times the UVC output over standard lamps of the same length. We have applied our proprietary LongLife+™ process to the amalgam line. Our special proprietary coating eliminates the common problem of accelerated depreciation so often associated with higher intensity lamps. Our lamps have an operating life of up to 16,000 hours, maintaining an end-of-life UVC output up to 90%

Advantages:

- Amalgam lamps offer the best performance over a broad air and water temperature range (4 – 40°C) with consistent UVC output; custom designs for higher temperature applications are available. They are available in both ozone generating and ozone-free lamp types.
- System designers have the ability to further decrease the number of lamps used in their treatment systems.



Our Proprietary Patented Pellet Amalgam Technology

Pellet amalgam technology has major benefits over spot amalgam technology in high power applications and hot ambient environments. Pellet amalgam lamps are designed to produce higher UVC at full power, as well as providing higher UV output under dimming conditions. Pellet amalgam technology benefits include greater efficiency in any mounting orientation (horizontal or vertical) and stable operation in more extreme environments.



Pellet Amalgam Lamp Features

- Outside diameters: up to 38mm
- Stable UVC performance available for extreme Air or Water temperature applications
- Higher wattage lamps = fewer lamps required = reduced capital and maintenance cost over system life
- Length: up to 2.5meters
- Electrical power: up to 1,200W
- Nominal UVC efficiency at 254nm: 35%
- Power per unit length: up to 5W/cm
- UVC intensity per unit length: up to 1,750mW/cm
- Ambient application temperature range: 4 - 40°C
- Operating hours: up to 16,000hrs¹
- UV Lamp maintenance: 90%¹

Spot Amalgam Lamp Features

- Outside diameters: 15mm – 28mm
- Stable UVC output performance over a broad Air or Water temperature range (4 – 40°C)
- Amalgam lamps = fewer lamps required when compared to traditional low pressure lamps = reduced capital and maintenance cost over system life
- Length: up to 2.5meters
- Nominal UVC efficiency at 254nm: 35%
- Power per unit length: up to 5W/cm
- UVC intensity per unit length: up to 1,750mW/cm
- Ambient application temperature range: 4 - 40°C
- Operating hours: up to 16,000hrs¹
- UV Lamp maintenance: 90%¹

Note 1: Lamp data is based on measurements performed under laboratory conditions in air at room ambient temperature. Measurements were performed on a high-frequency, current limited electronic ballast and represent average values.

Note 2: May require additional filament heating



Quartz Germicidal Lamps

The type of fused quartz used to make the body of the germicidal lamp determines the emission of the wavelength of the UV energy. “L” or “Low ozone” generating lamps transmit up to 90% of their energy at the 254nm wavelength and typically utilize a doped fused quartz/synthetic quartz, that blocks the emission of 185nm energy. “VH” or “Very high ozone” generating lamps are produced using clear fused quartz which allows for the transmission of energy at both 185nm and 254nm wavelengths. The 185nm energy reacts with the oxygen in the air to produce ozone. In applications where moderate amounts of ozone may be required, we can splice the two types of quartz together to form a custom “L” to “VH” ratio according to the customer’s specific requirements.

Other Lamp Sizes, Shapes
& Power Levels
Available Upon Request!

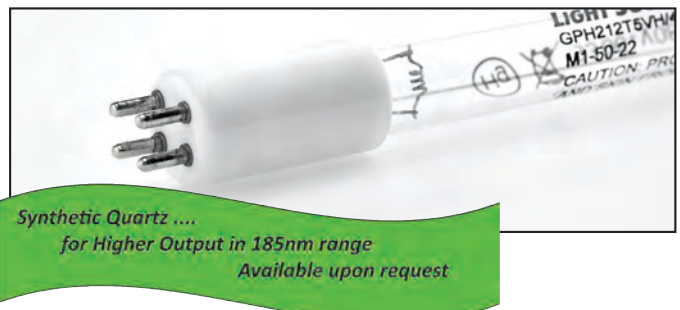

Standard Output Quartz Germicidal Lamps²

	Tube Diameter mm	BF - BF mm	Arc Length mm	Power ¹ W	Current ¹ A	Voltage ¹ V	UV output ¹ @ 254nm μW/cm ² W		Rated ¹ Life hrs.
Preheat Start Lamps - Low Ozone									
GPH212T5L	15	212	132	10	425	25	27	2.7	16,000
GPH287T5L	15	287	207	14	425	34	40	4	16,000
GPH295T5L	15	295	215	14	425	34	42	4.2	16,000
GPH303T5L	15	303	223	15	425	35	43	4.3	16,000
GPH357T5L	15	357	277	17	425	42	57	5.7	16,000
GPH436T5L	15	436	356	21	425	51	72	7.3	16,000
GPH793T5L	15	793	713	38	425	92	125	13.5	16,000
GPH843T5L	15	843	762	41	425	98	150	16	16,000
GPH1148T5L	15	1148	1067	55	425	135	180	22	16,000
GPH1554T5L	15	1554	1474	75	425	179	240	33	16,000
GPH1630T5L	15	1630	1550	79	425	189	252	34.5	16,000
Preheat Start Lamps - Ozone Generating									
GPH212T5VH	15	212	132	10	425	25	27	2.7	16,000
GPH287T5VH	15	287	207	14	425	34	40	4	16,000
GPH303T5VH	15	303	223	15	425	35	43	4.3	16,000
GPH357T5VH	15	357	277	17	425	42	57	5.7	16,000
GPH436T5VH	15	436	356	21	425	51	72	7.3	16,000
GPH793T5VH	15	793	713	38	425	92	125	13.5	16,000
GPH843T5VH	15	843	762	41	425	98	150	16	16,000
GPH1148T5VH	15	1148	1067	55	425	135	180	22	16,000
GPH1554T5VH	15	1554	1474	75	425	179	240	33	16,000
GPH1630T5VH	15	1630	1550	79	425	189	252	34.5	16,000

Note¹: Lamp data is based on measurements performed under laboratory conditions in air at room ambient temperature.

Measurements were performed on a high-frequency, current limited electronic ballast and represent average values at 1 meter.

Note²: Lamp data for clear fused quartz/synthetic quartz lamps are available upon request.

Typical Germicidal Lamp Configurations

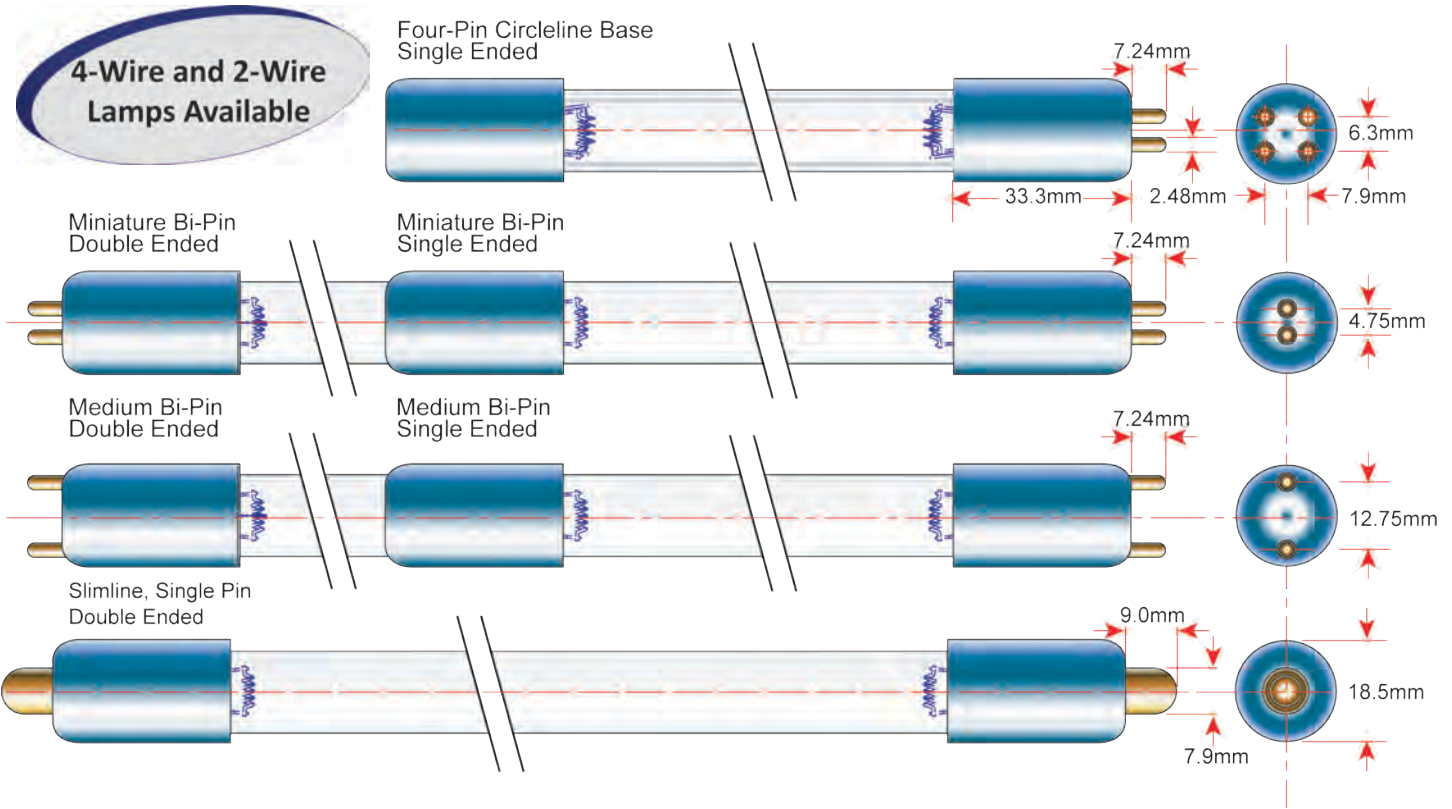
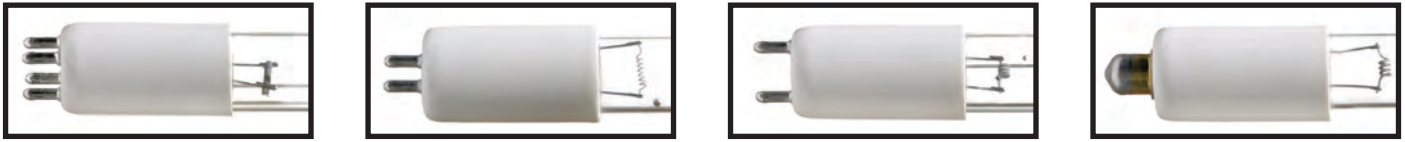

Standard Output Quartz Germicidal Lamps

	Tube Diameter mm	BF - BF mm	Arc Length mm	Power ¹ W	Current ¹ A	Voltage ¹ V	UV output ¹ @ 254nm μW/cm ²	W	Rated ¹ Life hrs.
Instant Start Lamps - Low Ozone									
G10T5L	15	357	277	17	425	42	57	5.7	16,000
G24T5L	15	692	612	32	425	77	95	11	16,000
G36T5L	15	843	762	41	425	98	150	16	16,000
G48T5L	15	1148	1067	55	425	135	180	22	16,000
G64T5L	15	1554	1474	75	425	179	240	33	16,000
G67T5L	15	1630	1550	79	425	189	252	34.5	16,000
Instant Start Lamps - Ozone Generating									
G10T5VH	15	357	277	17	425	42	57	5.7	16,000
G24T5VH	15	692	612	32	425	77	95	11	16,000
G36T5VH	15	843	762	41	425	98	150	16	16,000
G48T5VH	15	1148	1067	55	425	135	180	22	16,000
G64T5VH	15	1554	1474	75	425	179	240	33	16,000
G67T5VH	15	1630	1550	79	425	189	252	34.5	16,000

Note: Lamp data is based on measurements performed under laboratory conditions in air at room ambient temperature. Measurements were performed on a high-frequency, current limited electronic ballast and represent average values at 1 meter.



High Output (HO) Quartz Lamps

High Output (HO) lamps yield up to 66% more UV output when compared to standard lamps of the same length. HO lamps offer system designers unique opportunities to decrease the number of lamps required without compromising functionality of the system. This has the added potential benefits of reduced system footprint, increased efficiency and/or increased system capacity. HO lamps are produced and are available in the same configurations of standard lamps. Custom lengths and configurations may also be produced to the customer's specific requirements. The table below represents a sampling of the more common lamp sizes. We can custom design the ideal HO lamp for your unique application.

Preheat & Instant Start Configurations Available!

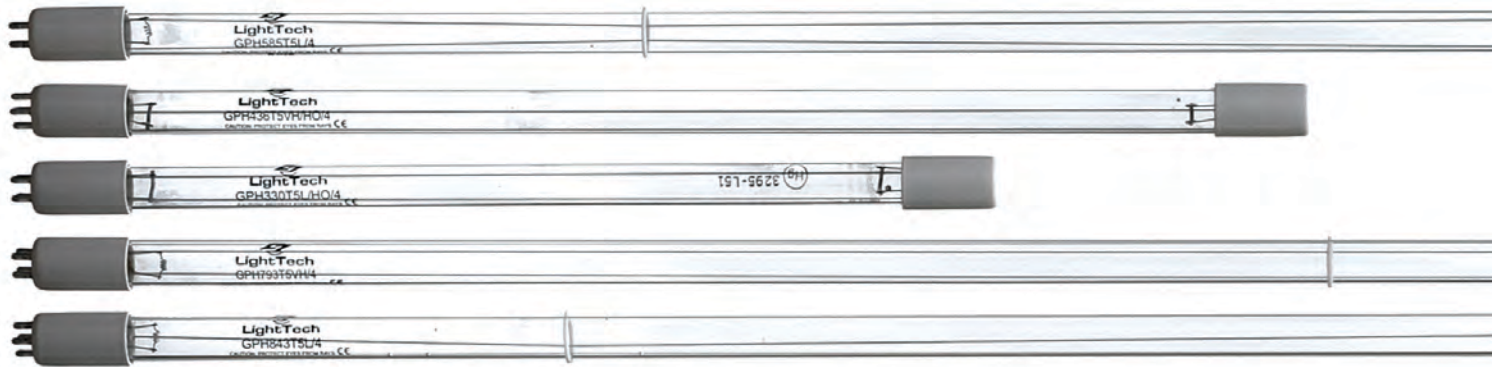

High Output (HO) Quartz Germicidal Lamps

	Tube Diameter mm	BF - BF mm	Arc Length mm	Power ¹ W	Current ¹ A	Voltage ¹ V	UV output ¹ @ 254nm μW/cm ² W		Rated ¹ Life hrs.
Low Ozone									
GHO436T5L	15	436	360	48	800	60	120	13	16,000
GHO36T5L	15	842	755	87	800	110	260	28	16,000
GHO846T5L	15	846	767	90	800	113	265	29	16,000
GHO893T5L	15	893	815	95	800	120	270	30	16,000
GHO64T5L	15	1554	1421	155	800	195	395	54	16,000
Ozone Generating									
GHO436T5VH	15	436	360	48	800	60	120	13	16,000
GHO36T5VH	15	842	755	87	800	110	260	28	16,000
GHO846T5VH	15	846	767	90	800	113	265	29	16,000
GHO893T5VH	15	893	815	95	800	120	270	30	16,000
GHO64T5VH	15	1554	1421	155	800	195	395	54	16,000

Note¹: Lamp data is based on measurements performed under laboratory conditions in air at room ambient temperature. Measurements were performed on a high-frequency, current limited electronic ballast and represent average values at 1 meter.



Germipak UV Cell Germicidal Lamps

LightSources and LightTech offer a series of integrated assemblies consisting of germicidal lamps encapsulated into a quartz sleeve. This cellular concept offers a wide range of custom design possibilities for OEM applications. Germipak UV Cell lamps are very economical components of Point of Use Water Systems and other applications. The standard units listed below have 15mm (T5) diameter lamps and 20.5 mm diameter sleeves.

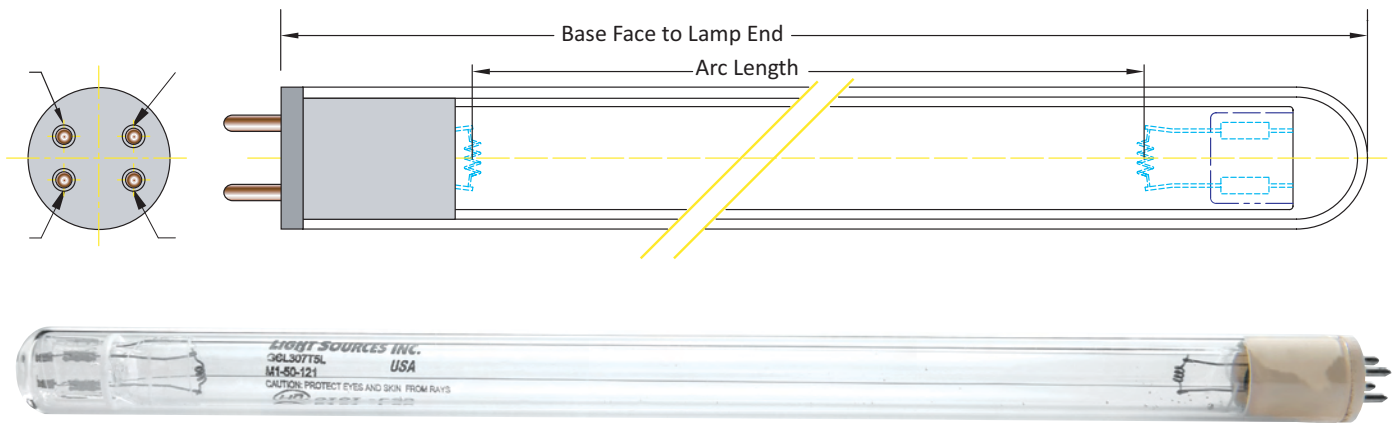

Germipak Quartz Germicidal Cell Lamps

	Tube Dia mm	Sleeve Dia mm	BF Lamp Ends mm	Arc Lgth mm	Power W	Current ¹ mA	Voltage ¹ V	UV output ¹ @ 254nm		Rated ¹ Life hrs.
								μW/cm ²	W	
Low Ozone										
GCL436T5L/Cell	15	20.5	436	356	21	425	51	65	6.5	16,000
GCL793T5L/Cell	15	20.5	793	713	38	425	92	111	12.1	16,000
GCL36T5L/Cell	15	20.5	842	762	41	425	98	130	14	16,000
Ozone Generating										
GCL436T5VH/Cell	15	20.5	436	356	21	425	51	65	6.5	16,000
GCL793T5VH/Cell	15	20.5	793	713	38	425	92	111	12.1	16,000
GCL36T5VH/Cell	15	20.5	842	762	41	425	98	130	14	16,000

Note: Lamp data is based on measurements performed under laboratory conditions in air at room ambient temperature. Measurements were performed on a high-frequency, current limited electronic ballast and represent average values at 1 meter.



Quartz U-Shaped Germicidal Lamps

Our quartz U-shaped germicidal and ozone lamps can produce more intense UV radiation in a limited space, allowing designers more flexibility. These lamps are available with center-to-center leg spacing from 22mm to 76mm, and offer the perfect solution by effectively doubling the arc length and UVC output.

Ask About Custom Configurations - Custom Lengths, bases and Leg Spacing are Available!

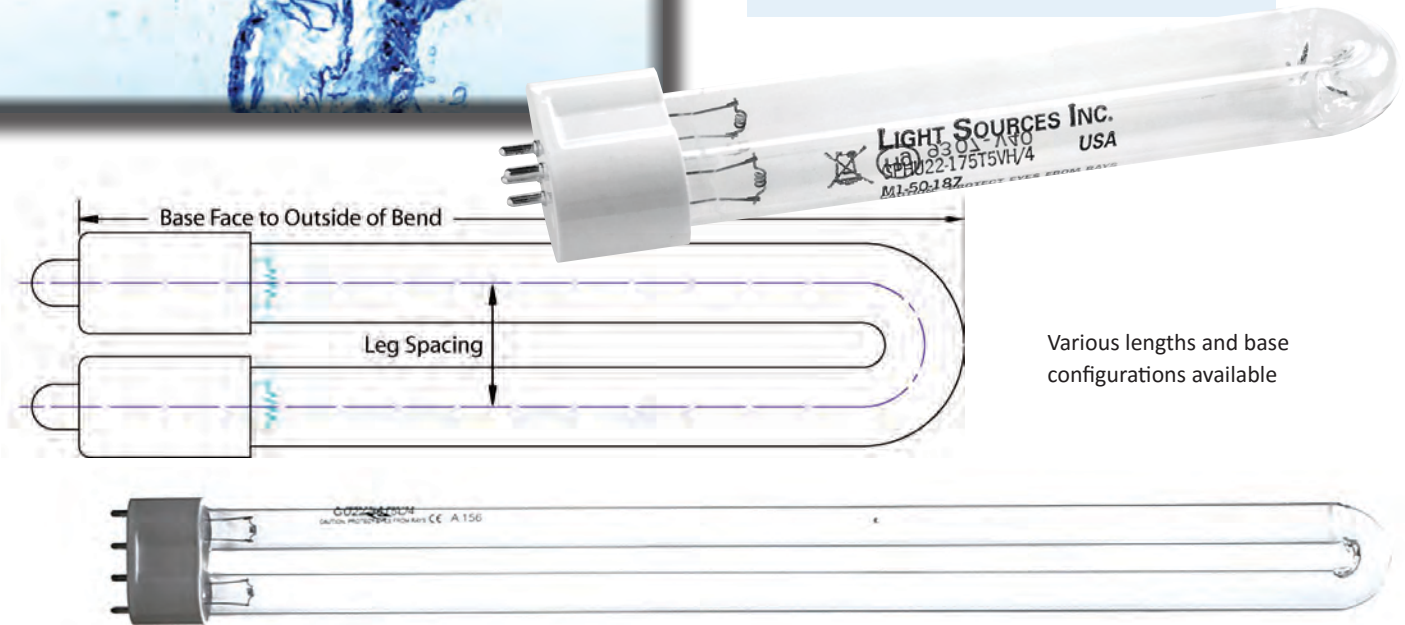

Quartz Germicidal U-Lamps

	Tube Diameter mm	BF - BF mm	Arc Length mm	Power ¹ W	Current ¹ A	Voltage ¹ V	UV output ¹ @ 254nm μW/cm ² W		Rated ¹ Life hrs.
Low Ozone									
GU76-10T5L	15	169/76	277	17	425	42	57	5.7	16,000
GU22-10T5L	15	186/22	277	17	425	42	57	5.7	16,000
GU22-390T5L	15	390/22	699	36	425	85	105	12	16,000
GU76-390T5L	15	390/76	711	37	425	88	110	12.8	16,000
GU76-36T5L	15	412/76	762	41	425	98	135	14.3	16,000
GU22-36T5L	15	429/22	762	41	425	98	135	14.3	16,000
Ozone Generating									
GU76-10T5VH	15	169/76	277	17	425	42	57	5.7	16,000
GU22-10T5VH	15	186/22	277	17	425	42	57	5.7	16,000
GU22-390T5VH	15	390/22	699	36	425	85	105	12	16,000
GU76-390T5VH	15	390/76	711	37	425	88	110	12.8	16,000
GU76-36T5VH	15	412/76	762	41	425	98	135	14.3	16,000
GU22-36T5VH	15	429/22	762	41	425	98	135	14.3	16,000

Note¹: Lamp data is based on measurements performed under laboratory conditions in air at room ambient temperature. Measurements were performed on a high-frequency, current limited electronic ballast and represent average values at 1 meter.



Soft Glass Germicidal Lamps

Soft glass lamps are specialty 254nm UVC emitting soft glass germicidal lamps. They operate on a variety of current (180 to 1,700mA inputs) and offer maximum efficiency in producing UVC radiation at 254nm.

We offer custom configurations to meet OEM requirements. Standard soft glass lamps are available in T4, T5, T6, T8 and T12 bodies. At our glass factory in Hungary, we engineer our germicidal soft glass to the highest standards and from the best materials. We design our soft glass specifically for low pressure mercury vapor lamps that serve the water and air purification industries. Our newly developed manufacturing process provides higher UVC output over the life of the lamp.

Advantages:

- Maximum efficiency in producing UVC radiation at 254nm
- Newly developed manufacturing process provides higher UVC output over lamp life
- Custom configurations available to meet OEM requirements

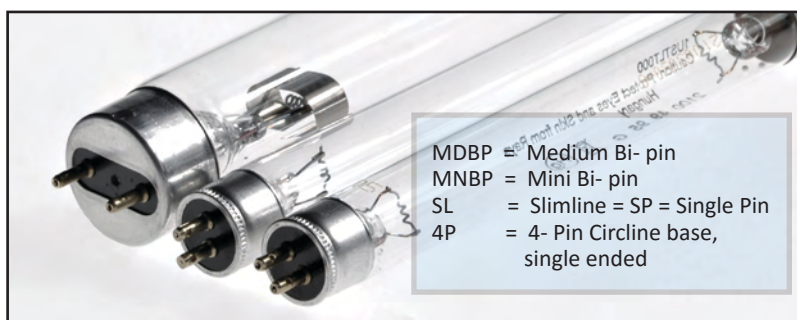

UV Soft Glass Germicidal Lamps

	Tube Dia mm	Base Config.	BF - BF BF-EOL mm	Arc Lgth mm	Power ¹ W	Current mA	Voltage ¹ Hi Freq ¹ V	UV output ¹ @ 254nm μW/cm ² W	Rated ¹ Life hrs.	
Standard Lamps										
LTC4T5	15.7	MNBP	134.7	77	4	180	23	9	0.9	9,000
LTC6T5	15.7	MNBP	210.9	154	6	180	34	16	1.6	9,000
LTC8T5	15.7	MNBP	287.1	231	8	180	45	21	2.1	9,000
LTC11T5	15.7	MNBP	210.9	154	11	280	40	22	2.2	9,000
LTC11T5SE	15.7	4P	241.1	170	12	280	43	24	2.4	9,000
LTC16T5	15.7	MNBP	287.1	231	16	370	44	40	4	9,000
LTC16T5SE	15.7	4P	317.3	245	17	370	46	42	4.2	9,000
LTC40T5	15.7	SL	842	767	41	425	98	141	15.6	9,000
LTC64T5	15.7	SL	1554	1481	76	425	180	225	31	9,000
LTC40T5SE	15.7	4P	842	767	41	425	98	141	15.6	9,000
LTC64T5SE	15.7	4P	1554	1481	76	425	180	225	31	9,000
LTC10T8	25.7	MDBP	330.3	247	10	280	36	23	2.3	9,000
LTC15T8	25.7	MDBP	436.2	353	15	350	44	47	4.8	9,000
LTC17T8	25.7	MDBP	588.6	505	17	280	61	44	4.5	9,000
LTC30T8	25.7	MDBP	893.4	810	30	380	80	100	11.3	9,000
LTC20T10	32	MDBP	588.6	495	20	370	55	65	6.7	9,000
High Output Lamps										
LTC80T5SE	15.7	4P	842	767	83	800	103	245	27	9,000
LTC125T5SE	15.7	4P	1554	1481	155	800	195	360	50	9,000
LTC25T8	25.7	MDBP	436.2	353	25	620	41	71	7.2	9,000
LTC55T8	25.7	MDBP	893.4	810	55	800	70	170	19	9,000
LTC75T8	25.7	MDBP	1198.2	1115	75	900	85	215	26.5	9,000
LTC115T12	37.7	MDBP	1198.2	1118	115	1700	69	280	34	9,000

Note¹: Lamp data is based on measurements performed under laboratory conditions in air at room ambient temperature. Measurements were performed on a high-frequency, current limited electronic ballast and represent average values at 1 meter.

UVC Compact Germicidal Lamps

Our companies offer a superb line of UVC emitting compact germicidal lamps for applications in small spaces. These lamps are consistently a favorite product among our clients. Compact lamps are available in a specially engineered two-tube linear innovative design, which allows a very uniform output. We provide all standard lamp sizes as well as custom configurations. The high efficiency of a compact lamp is created by leaving a small dead space at the end of each of the two parallel tubes. Because this area is not part of the path followed by the discharge (farther away from the center of the discharge column) the wall temperature is lower than anywhere else creating a dedicated mercury cold spot. These compact designs are available in soft glass (254nm only) and quartz glass for both 254nm and 185nm technology. Light Sources and LightTech also offer compact lamp designs using our patented pellet amalgam Technology. Providing outstanding UVC efficiency, it is one of the best value solutions available in today's market.



2G7

G23

2G11

Other Lamp Sizes, Shapes & Power Levels Available Upon Request!

UVC Compact Germicidal Lamps

	Tube Diameter mm	Base Config.	BF - OL (Max) mm	Power ¹ W	Current A	Voltage ¹ † 50/60 hz V	UV output ¹ @ 254nm µW/cm ² W	Rated ¹ Life hrs.	
Soft Glass Low Pressure									
LTC5W/G23	12.5	G23	83	5	180	34	9	1	8000
LTC7W/G23	12.5	G23	115	7	175	47	16	1.8	8000
LTC9W/G23/2G7	12.5	G23 / 2G7	145	9	170	60	22	2.4	8000
LTC11W/G23	12.5	G23	214	11	160	89	33	3.6	8000
LTC13W/G23	12.5	GX23	155.2	13	290	59	31	3.4	8000
Soft Glass High Power									
LTC18W/2G11	17.5	2G11	225	18	370	60	51	5.5	8000
LTC24W/2G11	17.5	2G11	320	24	350	87	65	7	8000
LTC35WHO/2G11	17.5	2G11	225	35	850	40†	105	11	8000
LTC36W/2G11	17.5	2G11	415	36	440	105	110	12	8000
LTC55W/2G11	17.5	2G11	535	55	540	103†	156	17	8000
LTC60WHO/2G11	17.5	2G11	415	60	670	120	169	18	8000
LTC95WHO/2G11	17.5	2G11	535	95	950	100†	304	32	8000
Quartz Glass High Power									
LTCQ35WHO/2G11	15	2G11	225	36	800	45†	110	11	9000
LTCQ36W/2G11	15	2G11	415	36	440	105	119	13	9000
LTCQ55W/2G11	15	2G11	535	55	540	103†	168	18	9000
LTCQ60WHO/2G11	15	2G11	415	60	670	118	179	19	9000
LTCQ95WHO/2G11	15	2G11	535	95	950	100†	328	34	9000
LTC95WHO/2G11	17.5	2G11	535	95	950	100†	304	32	8000

*Custom quartz high wattage (> 150W) pellet amalgam compact lamps available.

Note¹: Measurements were performed on a 50/60 Hz ballast and represent average values at 1 meter

†Measurements were performed on a high-frequency, current limited electronic ballast and represent average values at 1 meter.



UVC Subminiature Germicidal Lamps

Light Sources makes it possible to realize all the benefits of germicidal UVC light in limited space applications with our sub miniature UVC technology - Make the most of your design. These lamps are custom made to each OEM's innovative design.

Call and talk to us about your design ideas!



Typical Layout for a Straight Subminiature Germicidal UVC lamp

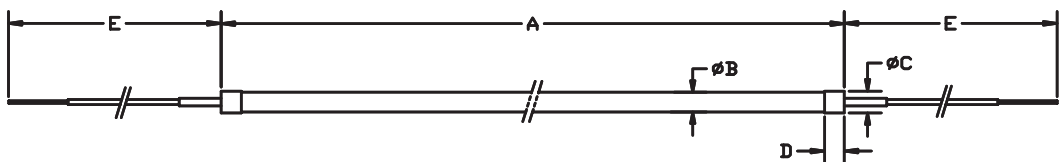

Let us know your unique ideas and lamp shapes!

- A - Base Face to Base Face
- B - Diameter
- C - Electrode Diameter
- D - Electrode Width
- E - Wire Length
- Base - None

Subminiature Germicidal Lamps

	Tube Dia mm	BF-BF mm	Dia Width mm	Dia Max mm	Wire Lgth mm	W	mA	V
Low Ozone								
GSM-3-51	3.0	51 ± 1.5	3.0	3.5	10.0	1.3	6	210
GSM-3-106	3.0	106 ± 1.5	3.0	3.5	10.0	1.7	6	280
GSM-3-175	3.0	175 ± 1.5	3.0	3.5	10.0	2.2	6	360
~~~~~								
GSM-4-75	4.0	75 ± 1.5	4.0	4.5	10.0	1.3	6	220
GSM-4-125	4.0	125 ± 1.5	4.0	4.5	10.0	1.6	6	270
GSM-4-200	4.0	200 ± 1.5	4.0	4.5	10.0	2.1	6	350

## Quartz Sleeves for Germicidal Lamps

Quartz sleeves are a good investment, offering protection against air and water flow, breakage, leakage, temperature fluctuations, and environmental hazards. LightSources offer a variety of standard and custom quartz sleeves and jackets that can be applied to a range of germicidal UVC lamp types, including standard, high output (HO), and amalgam. We offer OEMs numerous options, such as open, closed (domed), flared or beaded end and fire polish finishing. Our quartz sleeves are available in a wide array of diameters and lengths for use in air purification units, water disinfection units, photochemical reactors, and other specialized equipment.

### Quartz Sleeves/Jackets: Most Commonly Used

I.D. mm	O.D. mm	Wall Thickness mm
17.0	19.0	1.00
18.0	20.5	1.25
19.6	22.0	1.20
20.0	22.0	1.00
20.0	22.5	1.25
20.0	23.0	1.50
20.0	24.0	2.00
22.0	24.5	1.25
22.0	25.0	1.50
25.0	28.0	1.50
26.0	30.0	2.00
26.4	30.0	1.80
27.0	30.0	1.50
28.0	32.0	2.00
30.0	33.0	1.50
32.0	36.0	2.00
34.0	38.0	2.00
35.0	38.0	1.50
35.0	40.0	2.50
38.0	42.0	2.00
42.0	45.0	1.50
44.0	48.0	2.00
45.0	48.0	1.50
50.0	54.0	2.00

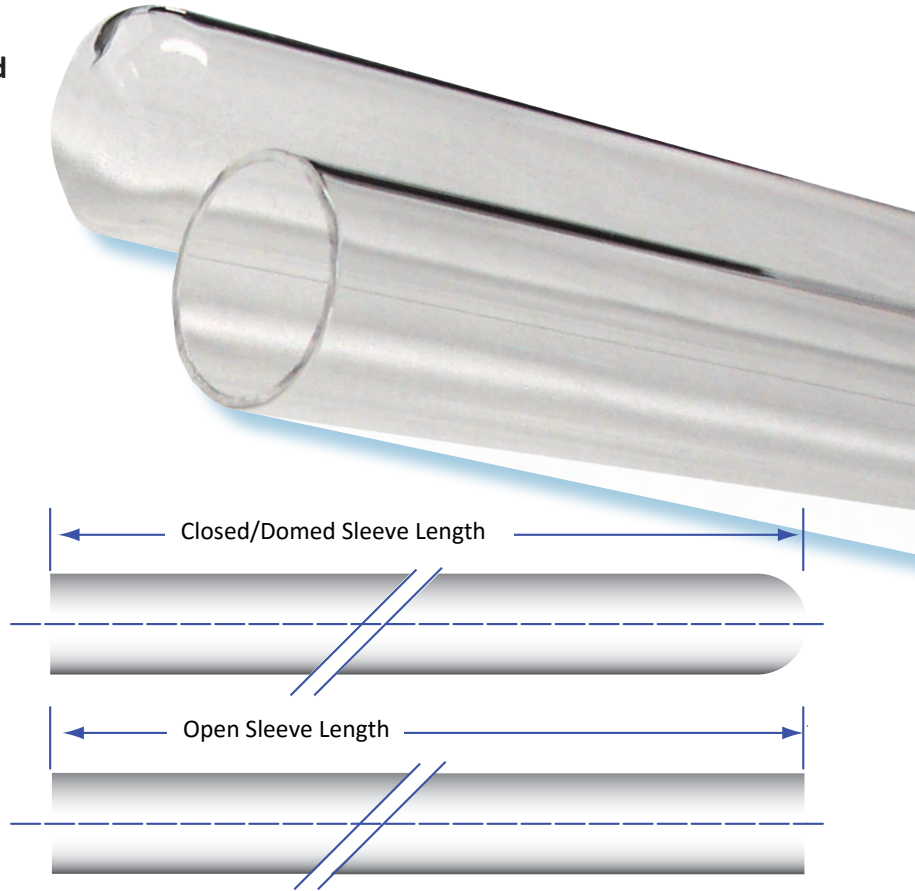

## The Shatter + Technology

Lamp Casing that Protects against Glass Fragments



The new **Shatter ProTech Technology** from Light Sources adds substantial value and “peace-of-mind” to a very wide variety of applications. The new **Shatter ProTech** shield is a cost-effective solution to glass and mercury containment, while optimizing light output.

**Shatter ProTech** lamps provide maximum consumer safety with minimal output loss. The UVC transmission loss through the ProTech sleeve is only 5% more than that of a quartz sleeve.

No lamp is too long, short, big or small for the **Shatter ProTech Technology** to do its job - protect and transmit light energy!

*Note: The Shatter+ Technology does not guarantee water tightness.*

## The Shatter + Technology

- Reduced potential for mercury contamination when breakage occurs
- Heat and acid resistant
- Excellent for applications that involve food or drinking water.
- High performance at a low cost
- Environmentally friendly and safe





## Custom Bases for the OEM

Not only does LightSources produce custom lamp designs, but we also work with OEM's and system designers to produce unique end fittings and matching sockets. By offering different/unique solutions we help keep your systems competitive in global markets and **protect your aftermarket replacement lamp business**. If you don't see what you are looking for, simply sketch out your design and send it to us and we will work with you to make your vision come to life.

If you have a special connector or wire requirement, Please ask.



## What's Your Competitive Advantage?

Our custom designed lamp bases are just one of the many reasons why our customers come back to us so we can help them with their special needs.

We work with OEM's to ensure that the custom lamps only fit into their custom systems. Benefit from greater flexibility in your system design and distinguish your product with identifiable and unique bases/sockets, end caps or pin configurations. Add value to the components and parts in your systems by creating a business identity.

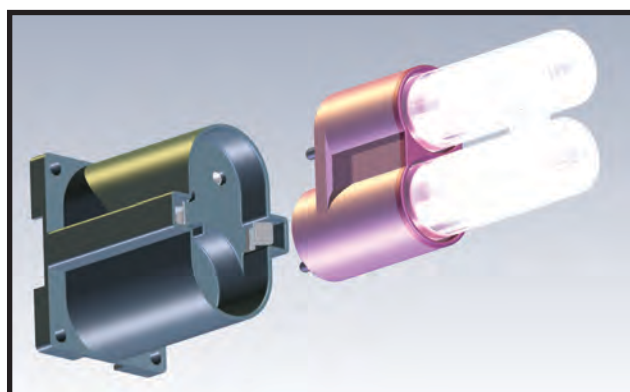

Bases and sockets can be manufactured in various colors and can even be labeled with your corporate logo to enhance brand recognition.

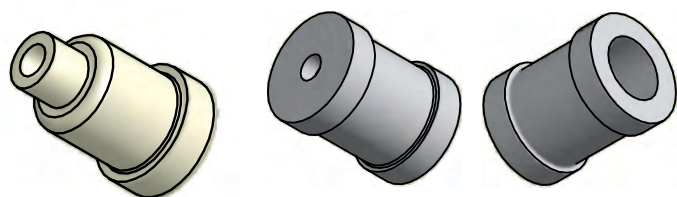

Examples of Custom Proprietary Non-Standard Bases

## R.P.T. UVC Germicidal Fixtures

Retro-fit system to stops Bacteria & Molds

Respiratory diseases and allergies are becoming more common occurrence in the world wide, whether it is at home or in the work place. HVAC systems, due to the high density of moisture, can easily harbor and distribute molds and and other disease-causing bacteria within thier heating and cooling ventilation systems.

The RPT UVC lamps can be quickly and efficiently installed in any new or existing HVAC system (heating ventilation and

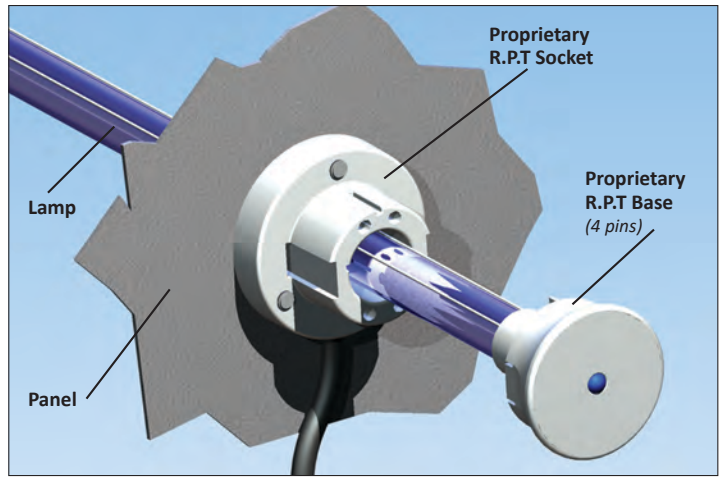

air conditioning), helping to end major health concerns. UVC light, with most of the light energy focused at 254nm, is the most effective germicidal wavelength in the entire UV light spectrum. UVC light literally attacks DNA-based airborne pollutants and mold spores by breaking DNA molecular bonds rendering them unable to reproduce.

### Benefits of UVC used in a HVAC System

- Reduces, or eliminates, harmful airborne contaminants from air stream
- Provides a fresher, cleaner and purer air to breathe
- Diminishes respiratory diseases and allergies
- Eliminates odor and slimy build up associated with mold
- Zero UV exposure RPT lamps are placed inside the duct of the HVAC system and can be safely replaced

A dirty coil in an HVAC system will lead to impurities in the overall air stream. Pathogenic bacteria and molds can result.

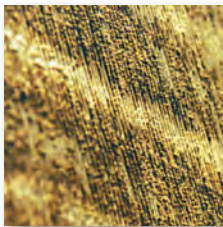
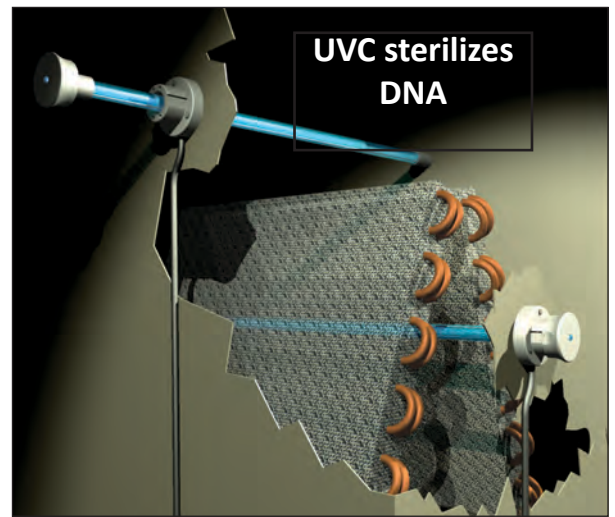

#### Dirty AC Coil

Air contaminated -  
Illness sensitivity increased.



#### Clean AC Coil

Stops bacteria & molds from starting and reproducing- Fresh, pure and clean air.

### RPT Lamps

	Tube Dia mm	Sleeve Dia mm	BF Lamp Ends mm	Arc Lgth mm	Power W	Current ¹ mA	Voltage ¹ V	UV output ¹ @ 254nm $\mu\text{W}/\text{cm}^2$	W	Rated ¹ Life hrs.
<b>Low Ozone</b>										
GPH357T5/HO/RPT	15	20.5	357	272	35	510	70	75	6.9	16,000
GPH406T5L/HO/RP	15	20.5	406	322	40	800	58	100	10.0	16,000
GPH508T5L/HO/RPT	15	20.5	508	424	50	800	80	130	15.0	16,000
GPH560T5L/HO/RPT	15	20.5	560	476	57	800	86	150	17.0	16,000
GPH610T5L/HO/RPT	15	20.5	610	526	65	800	93	175	19.0	16,000







## All in One Submersible Lamp

The All-In-One Submersible lamp is a encapsulated germicidal lamp in an water tight quartz sleeve. This innovative design allows the lamp to be completely submerged in liquid.

Lamps come prewired with a four-wire connection that can be cut to custom lengths. The most common application for these lamps

is in sterilizing the inside of liquid storage tanks. Tank head space and surface sterilization can be achieved as well as the sterilization of the liquid contents of a holding tank. In house laboratory tests have shown an water tight seal has held up in continuous shallow water immersion for 12 months.

- All-In-One lamp
- Submersible
- Encapsulated



**NEW**

***Need Help with Your Lamp Ideas***



Contact our Light Sources & LightTech Sales Staff!

We work with OEM's and system designers to produce unique solutions that bring your ideas to life.



## MPUV Lamps for UVA Curing and UVC Disinfection



Our Companies understand medium pressure and high pressure ultraviolet lamps. We make it easy and convenient for you to find the best lamp for your curing applications. Our sales team can help guide you through the design process for your specific application. Ultraviolet curing lamps are used in applications where UV-light activated inks, bonds, adhesives, and finishes (lacquers, glazes and varnishes) are used.

Our companies manufacture the three main types of UV Curing lamps - High Pressure UV (HPUV), Medium Pressure UV (MPUV) discussed here, and Amalgam UV lamps. With over 40 years of experience in the manufacturing of HPUV, MPUV, and LPUV lamps, our expertise and knowledge make it easy for you to find the best lamp for your UV curing needs for water/air disinfection needs.

### Medium Pressure UV Lamps

High powered MPUV/ MPHO lamps emit energy over the 200 through 400 nm (polychromatic) range as well as operating at a much higher temperature range of 600 - 900°C. (1112- 1652°F). Lamps are available from 100 watts per inch to over 700 watts per inch (39 - 275 w/cm) , with arc lengths ranging from 2 to 85 inches [50 - 2159 mm]. Our companies offer you the ability to customize your MPUV curing lamps to your own specification and application needs through our custom design form. For special OEM designs, we provide technical consulting with our engineering staff and private label when requested

### Chemical Additives/Doped Lamps

MPUVA curing lamps are much higher power than a Low Pressure (LP) germicidal lamps. Standard MPUVA mercury curing lamps have wavelength output peaks at 254nm and 365nm. Other applications call for higher wavelength peaks such as 385nm and 417nm.

To reach these additional radiation peaks - additive lamps are created by dosing the lamps with heavy metal compounds (metal halide). Commonly requested additives for MPUVA lamps are Gallium (400-450nm), Lead, and Iron (350- 400nm). When adding a metal halide to a lamp, all the characteristic wavelengths of that metal will be produced and the mercury spectra will have its lines lowered/changed in intensity.

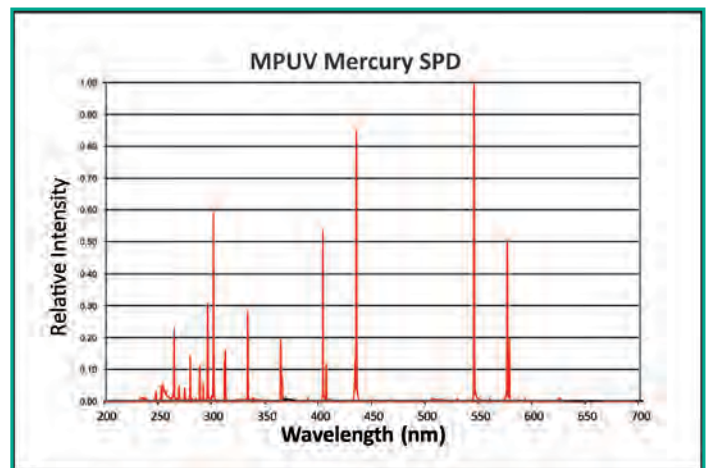

All the materials in the arc are interactive. Metal halide lamps also require specific ballasts designed to operate *metal halide lamps*. The starting voltage for an additive lamp is higher than for a standard mercury lamp by several hundred volts and can vary with lamp age and the number of times the lamp is ignited.

*(The prediction intensity for specific lines in a metal halide lamps can only be stated based on the lines listed in spectroscopy manuals, a "strong" lines and "persistent" lines will be more intense.)*



# Custom Lamp Design Requirements

## Basic Lamp Types for Metal and Ceramic Base Designs

### Physical Design Requirements

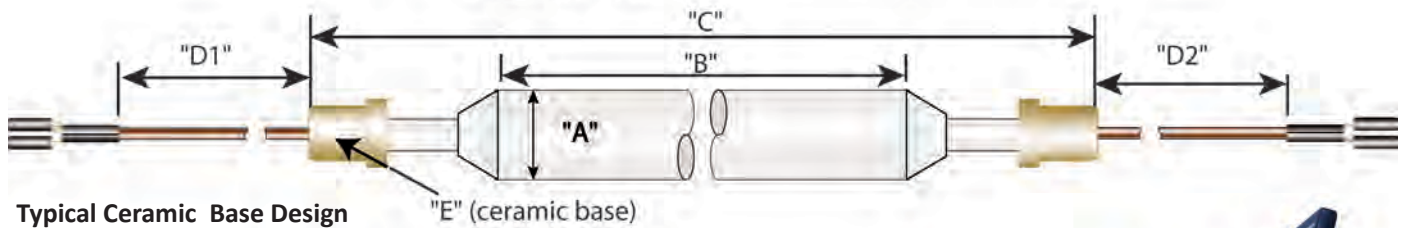
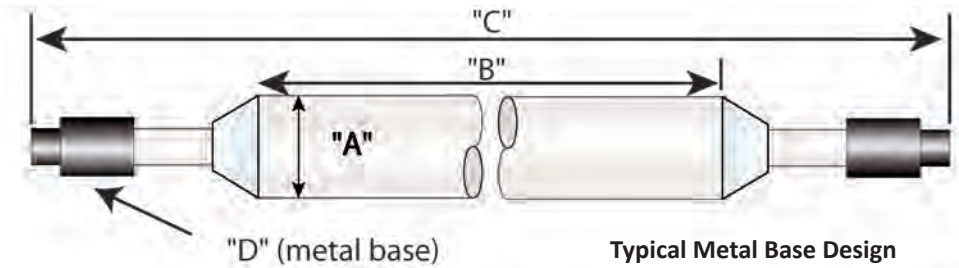

### Design Requirements

#### Electrical:

Lamp Voltage = _____ V  $\pm$  5% (Standard) - _____ V  
 Lamp Current = _____ A (nominal)  
 Total Wattage = _____ KW  
 Max Starting Voltage = _____ V

#### Physical Characteristics:

Outside Diameter (A) = _____ mm  
 Arc Length (between coatings) (B) = _____ mm  
 Overall Length (C) = _____ mm

#### Bases:

If Metal Base (D) = _____  
 If Ceramic Base (E) = _____

#### Wire:

Wire Lengths (D1) = _____ mm  
 Wire Lengths (D2) = _____ mm

#### Did you know?.....

*Metal halide lamps require specific ballasts designed to run metal halide lamps. The starting voltage for an additive lamp is higher than for a standard mercury lamp by several hundred volts and can vary with lamp age and number of times the lamp is ignited.*



#### Terminations:

- None- Bare wire
- Lugs (F) :
- Ring Lug, #8 screw
- Ring Lug, #10 screw
- Ring Lug, 1/4" screw
- Ring Lug, Metric M5 screw
- Spade Lug, #8 screw
- Spade Lug, #10 screw
- 1/4 Female Quick Disconnect c Wire Pin
- Other-Specify_____

Not only does LightSources produce custom lamp designs, but we also work with OEM's and system designers to produce unique products. By offering different/unique solutions we help keep your systems competitive in global markets and protect your aftermarket replacement lamp business.

## Chemical Additives/Doped Lamps

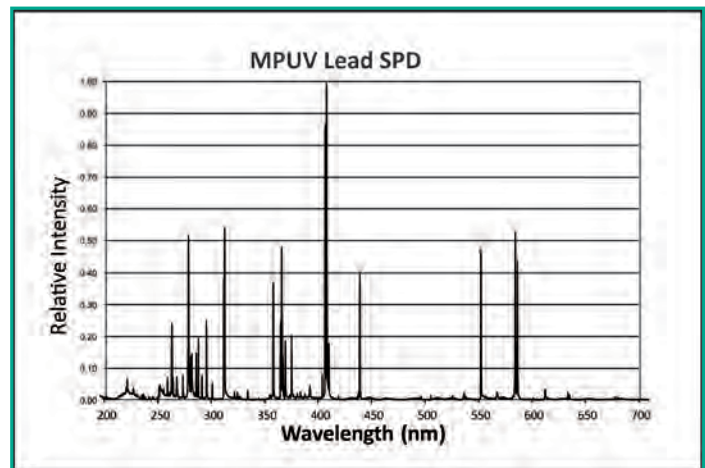
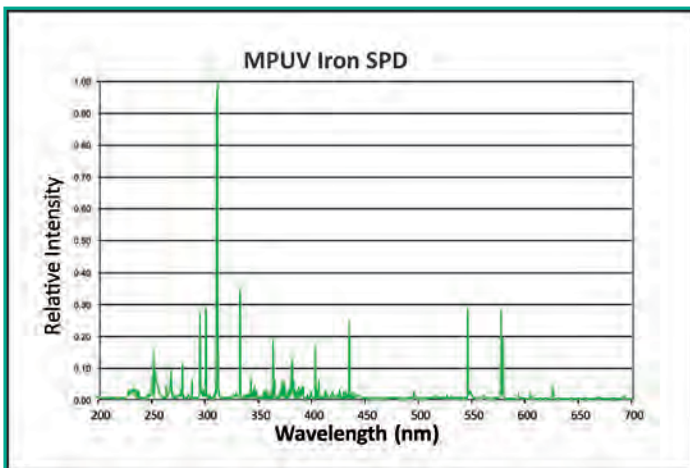
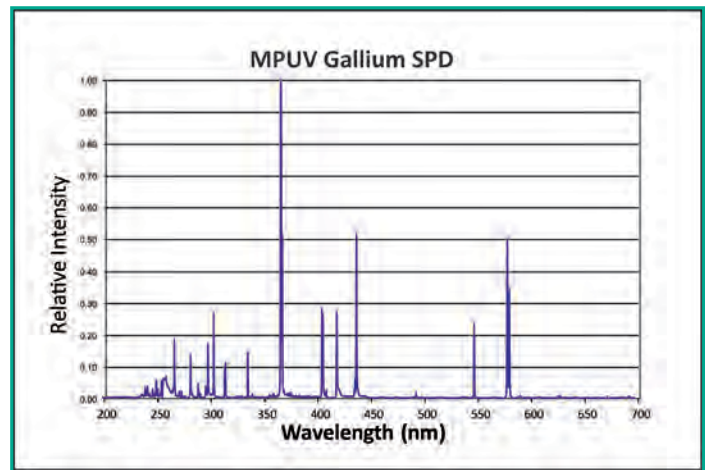
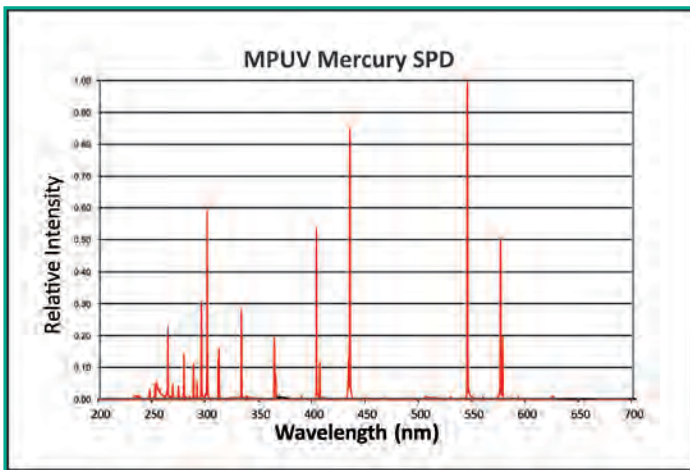

### Common Quartz Diameters:

Most sizes are available in both ozone free and ozone producing quartz.

R	11 x 13	1 mm wall
K	13 x 15	2 mm wall
E	16 x 18	2 mm wall
E2	16 x 19	1.5 mm wall
L	17 x 20	1.5 mm wall
A	18 x 20.5	2.5 mm wall
B	20 x 22.5	2.5 mm wall
C	22 x 25	3 mm wall
M	22 x 26	3 mm wall
J2	24 x 28	2 mm wall
J	25 x 28	3 mm wall

### Did you know?.....

Mercury (Hg) content of the lamp varies by lamp type but is typically between 10 and 300mg on average.

Newer formulations of inks, coatings and adhesives are made with photoinitiators and resin that require the correct UV light to polymerize and harden/cure.

### Ozone Free Quartz

vs.

### VH/Ozone Producing Quartz

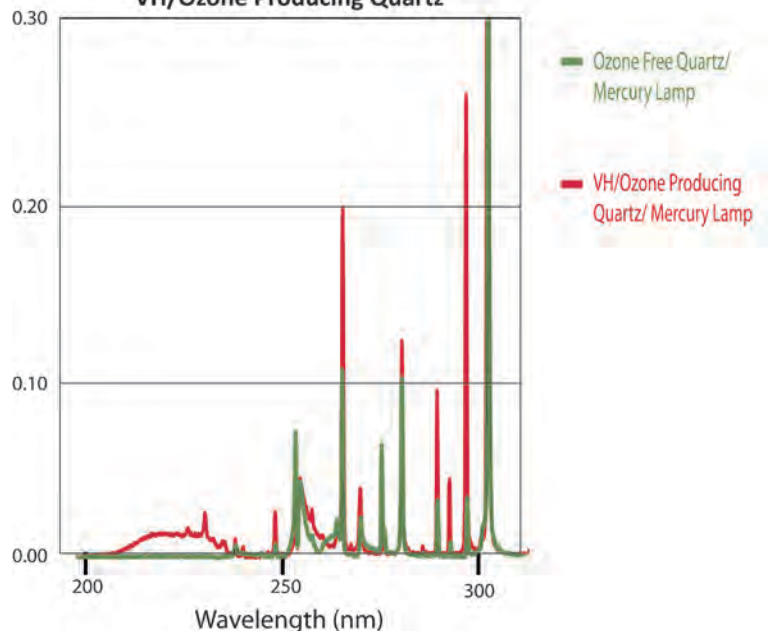

### Ozone-Free Quartz:

Allows the transmission of the UV-B and UV-A spectrum while blocking the wavelengths in the lower region that can cause ozone generation.

Ozone free quartz's low mercury line at 253.7 nm makes it very efficient for disinfecting applications and various other UV treatments.



## Commonly used Bases for MPUV Lamps

Our companies distinguish ourselves not only by our ability to produce customized lamps, but also by working with OEMs and designer to produce unique bases. Different lamp base solutions that keep your systems competitive in global markets.

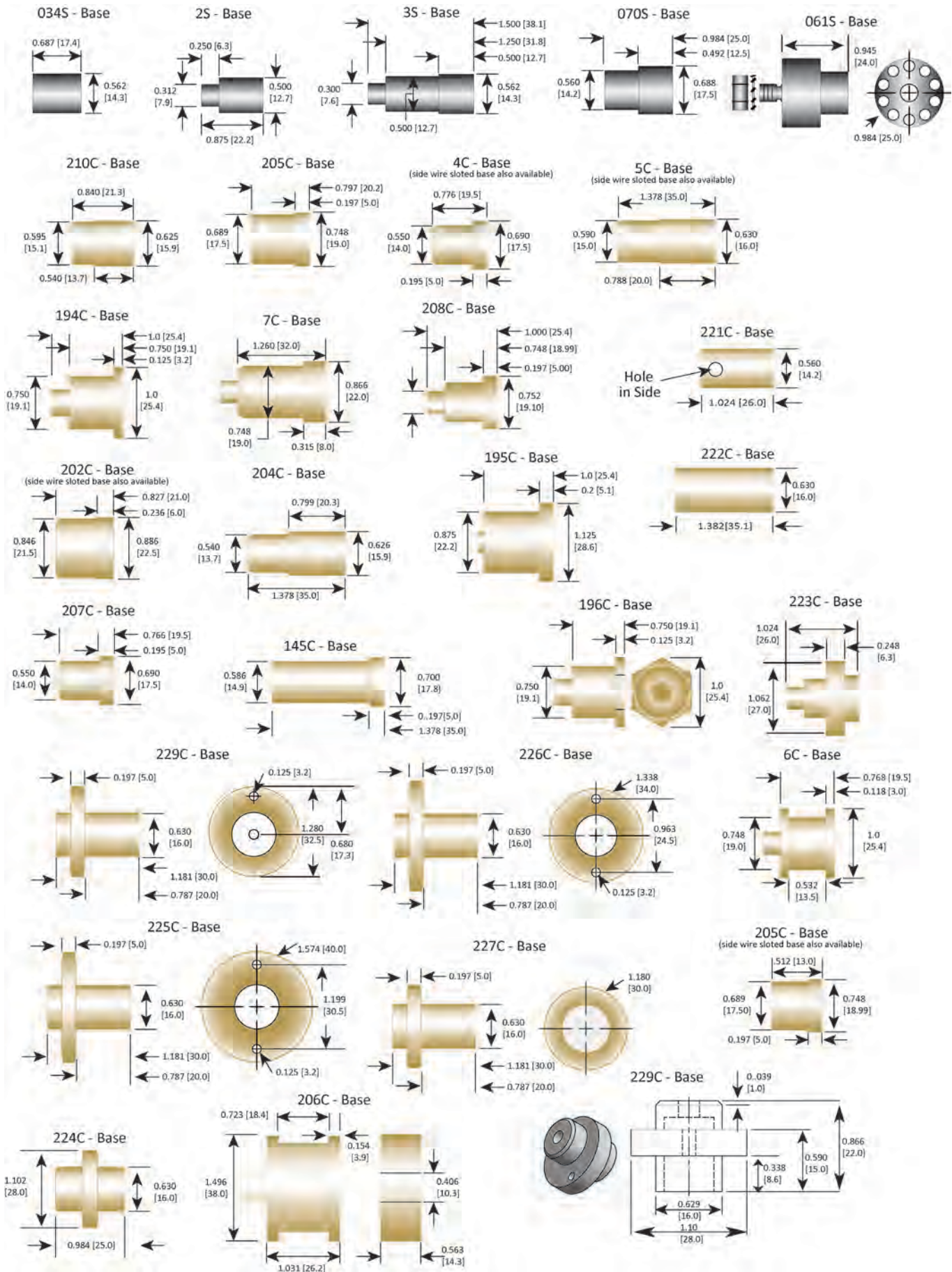



# Metal Halide Lamps

for the Printing /Curing Industry

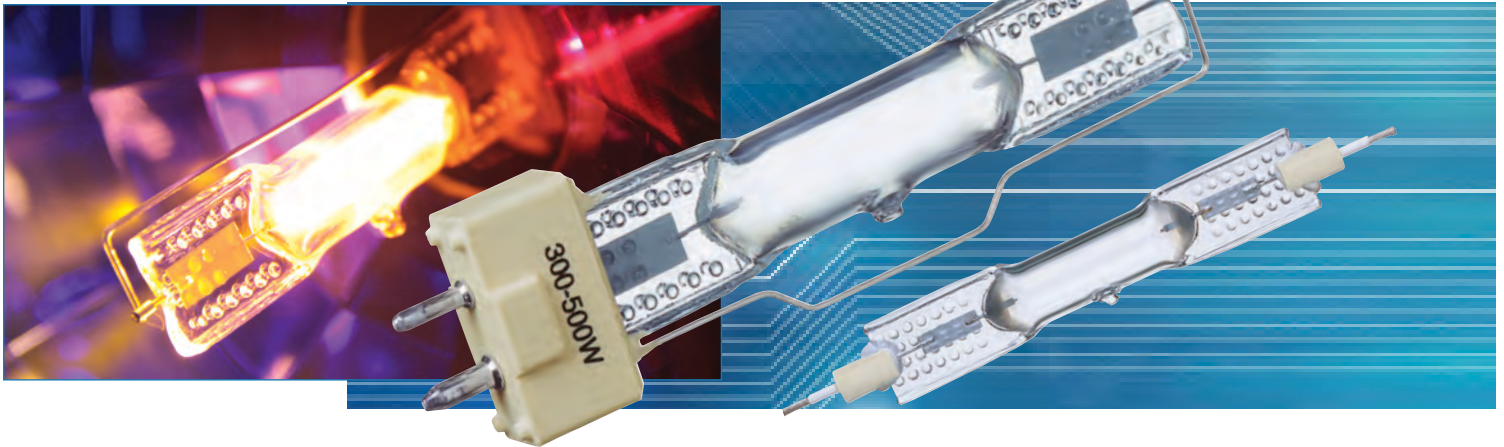

Metal Halide lamps are mercury high pressure UV lamps where the spectra are matched with the activation spectrum of photo initiators and substrates by adding metal halides such as iron, gallium, or a combination of both additives. Your ink supplier should be able to provide you with the correct output spectrum required to cure the ink you are using. Once you provide us with the correct output spectrum that is required, we can begin to work together to design the correct lamp for your specific application. Since we are a custom lamp manufacturer, we can change the metal halide content and lamp operating parameters to meet your specifications and processes.

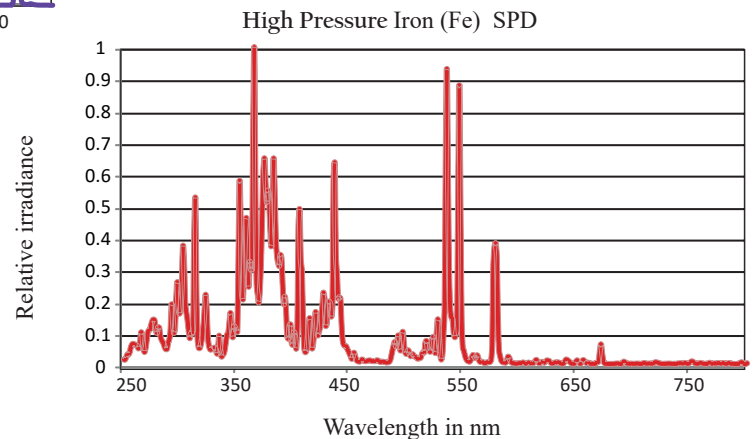
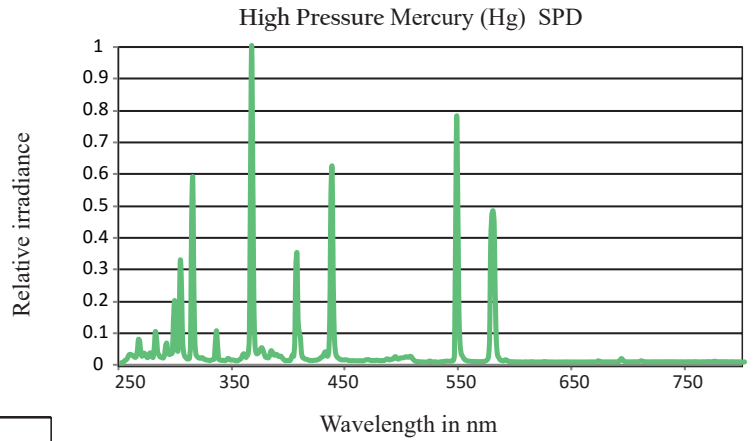
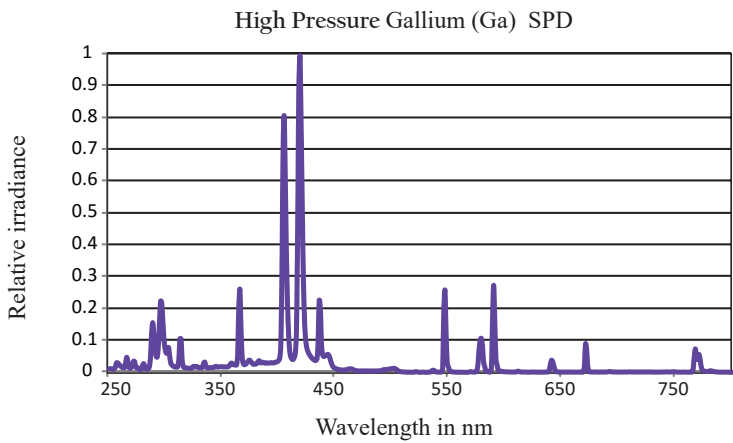

## Single and Double Ended High Pressure Metal Halide Lamps

Typical Lamp Configurations - Custom Design Available

The product range for MH lamps extends from 200 watts to 2000 watts in various designs- both single and double ended

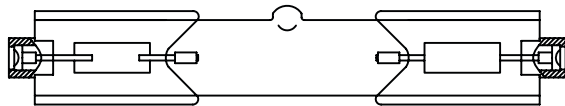

HTC Style with R7s base

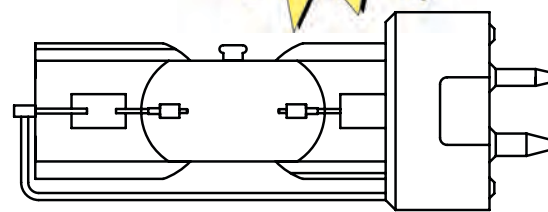

HSC Style with GY9.5 base

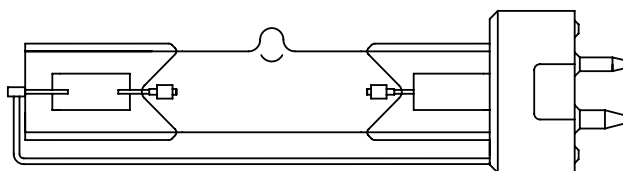

HSC Style with GY9.5 base

**Available in -  
Hg, Fe & Ga**

**Industrial Applications-**

- Automotive
- Pharmaceutical
- Reprography
- Photochemistry
- Photo Polymerization
- Curing of paints /lacquers
- Curing of adhesives
- Sewer rehabilitation
- Curing coatings on medical equipment
- Ballast water sterilization
- Cosmetic
- Food & beverage

	Supply Power [W]	Operating Voltage [V]	Voltage [V]	Current [A]	Arc Length [mm]	Tube Diameter [mm]
<b>Mercury (Hg)</b>						
	200	230	130	2.0	22	12
	250	230	130	2.2	15	14
	400	230	130	3.5	33	14
	500	230	115	4.5	32	16
	600	230	130	5	45	14
	800	230	130	7	29	24.5
	1000	230/400	130/195	9/5,5	48/52	28
	2000	400	250	9	72	28
<b>Iron (Fe)</b>						
	200	230	130	2.0	22	12
	250	230	130	2.2	15	14
	400	230	130	3.5	33	14
	500	230	115	4.5	32	16
	600	230	130	5	45	14
	800	230	130	7	29	24.5
	1000	230/400	130/195	9/5,5	48/52	28
	2000	400	250	9	72	28
<b>Gallium (Ga)</b>						
	200	230	130	2.0	22	12
	250	230	130	2.2	15	14
	400	230	130	3.5	33	14
	500	230	115	4.5	32	16
	600	230	130	5	45	14
	800	230	130	7	29	24.5
	1000	230/400	130/195	9/5,5	48/52	28
	2000	400	250	9	72	28

Note: lamp data is based on measurements performed under laboratory conditions in air at room ambient temperature



**LightTech Lamp  
Technology, Ltd.**

**LightSources, Inc.**

**LightSources (Chi-  
na) Co., Ltd.**



**LightSources**

**USA/North America**

**LightSources, Inc./ LCD Lighting, Inc.**  
37 Robinson Blvd.  
Orange, CT 06477  
USA  
phone: +1 203-799-7877  
phone: +1 800-826-9465  
fax: +1 203-795-5267  
email: info@light-sources.com



**LightTech**

**Europe**

**LightTech Lamp Technology, Ltd.**  
Hegyvejaro ut 1.  
2120 Dunakeszi  
Hungary  
phone: +36 27 541-800  
fax: +36 27 390-099  
email: info@lighttech.hu



**LightSources  
China**

**Asia**

**LightSources (China) Co., Ltd.**  
Floor 3, Building 10, Lane 561  
North Nujiang Rd,  
Putuo District, Shanghai 200333  
China  
phone: +86 21 526 62 921/ 5266 2927  
fax: +86 21 52662 921  
email: saleschina@light-sources.com